

PMC Panel Mount Power Supply

12V 100W 1 Phase / PMC-12V100W1AA

PMC



Highlights & Features

- Universal AC input range from 85Vac to 264Vac without power de-rating
- Full Aluminum casing for light weight and corrosion resistant handling
- High MTBF > 700,000 hrs. as per Telcordia SR-332
- Overvoltage / Overcurrent / Over Temperature Protections

Safety Standards



CB Certified for worldwide use

Model Number: PMC-12V100W1AA
Unit Weight: 0.45 kg
Dimensions (H x W x D): 158 mm x 97 mm x 38 mm

General Description

The new Panel Mount Power Supply is the latest offering from one of the world's largest power supply manufacturers and solution providers - Delta. The product range offers a nominal output voltage of 12V, a wide temperature range from -10°C to +70°C and a highly dependable minimum holdup time. The state-of-the-art design is made to withstand harsh industrial environments. What makes the product stand out from the crowd is its lightweight full aluminum body design which can withstand shock and vibration according to IEC60068-2. Delta's Panel Mount Power Supply also offers overvoltage and overload protection. Using a wide input voltage range design, it is compatible worldwide. The input also includes DC operating voltage from 125-375Vdc. Best of all, this excellent design and quality does not come with a big price tag.

Model Information

PMC Panel Mount Power Supply

Model Number	Input Voltage Range	Output Voltage	Output Current
PMC-12V100W1AA	85-264Vac (125-375Vdc)	12Vdc	8.33A

Model Numbering

PMC	12V	100W	1	A	A
PMC Series	Output Voltage	Output Power	Single Phase	Delta Standard	Terminal Block Connector

PMC Panel Mount Power Supply

12V 100W 1 Phase / PMC-12V100W1AA

Specifications

Input Ratings / Characteristics

Nominal Input Voltage	100-240Vac
Input Voltage Range	85-264Vac
Nominal Input Frequency	50-60Hz
Input Frequency Range	47-63Hz
Nominal DC Input Voltage	125-250Vdc
DC Input Voltage Range	125-375Vdc
Input Current	< 2.0A @ 115Vac, < 1.1A @ 230Vac
Efficiency at 100% Load	> 84% @ 115Vac, > 86% @ 230Vac
Max Inrush Current	< 60A @ 115Vac, < 130A @ 230Vac
Power Factor	Conform to EN61000-3-2, Class A
Leakage Current	< 1mA @ 240Vac

Output Ratings / Characteristics

Nominal Output Voltage	12Vdc
Output Voltage Tolerance	± 2% (initial set point tolerance from factory)
Output Voltage Adjustment Range	11-14Vdc
Output Current	8.33A
Output Power	100W
Line Regulation	< 0.5% typ. (@ 85-264Vac input, 100% load)
Load Regulation	< 1% typ. (@ 85-264Vac input, 0-100% load)
PARD (20MHz)	< 100mVpp
Rise Time	< 30ms @ nominal input (100% load)
Start-up Time	< 1000ms @ nominal input (100% load)
Hold-up Time	> 15ms @ 115Vac, > 80ms @ 230Vac (100% load)
Dynamic Response (Overshoot & Undershoot O/P Voltage)	± 5% @ 0-100% load
Start-up with Capacitive Loads	8,000µF Max

Mechanical

Case Cover	Aluminium
Dimensions (L x W x D)	158 mm x 97 mm x 38 mm
Unit Weight	0.45 kg
Indicator	Green LED (DC OK)
Cooling System	Convection
Terminal	Input and Output
Wire	M3.5 x 7 pins (Rated 300VAC/15A) AWG 22-14
Noise	Sound Pressure Level (SPL) <40dBA

PMC Panel Mount Power Supply

12V 100W 1 Phase / PMC-12V100W1AA

Environment

Surrounding Air Temperature	Operating	-10°C to +70°C
	Storage	-25°C to +85°C
Power De-rating		> 50°C de-rate power by 2.5% / °C
Operating Humidity		< 95% RH
Operating Altitude		3,000 Meters
Shock Test (Non-Operating)		IEC60068-2-27, 30G (300m/S ²) for a duration of 18ms 1 times per direction, 6 times in total
Vibration (Non-Operating)		IEC60068-2-6, 10Hz to 150Hz @ 50m/S ² (5G peak); 20 min per axis for all X, Y, Z direction
Pollution Degree		2

Protections

Overvoltage		16V +10%/-5%, SELV output, Hicc-up Mode, Non-Latching (Auto recovery).
Overload / Overcurrent		> 120% of rated load current, Hicc-up Mode, Non-Latching (Auto recovery).
Over Temperature		< 75°C Ambient Temp@ 100% load, Non-Latching (Auto-recovery).
Short Circuit		Hicc-up Mode, Non-Latching (Auto-recovery when the fault is removed).
Protection Against Shock		Class I with PE* connection

*PE: Primary Earth

Reliability Data

MTBF		> 700,000 hrs, as per Telcordia SR-332
Expected Cap Life Time		10 years (115Vac & 230Vac, 50% load and 40°C)

PMC Panel Mount Power Supply

12V 100W 1 Phase / PMC-12V100W1AA

Safety Standards / Directives

Electrical Safety	TUV Bauart to EN60950-1, UL/cUL recognized to UL60950-1 and CSA C22.2 No. 60950-1, CB scheme to IEC60950-1, CCC to GB4943
CE	In conformance with EMC Directive 2004/108/EC and Low Voltage Directive 2006/95/EC
Material and Parts	RoHS Directive 2011/65/EU Compliant
Galvanic Isolation	Input to Output Input to Ground Output to Ground
	3.0 KVac 1.5 KVac 500 Vac

EMC

EMC / Emissions	CISPR22, EN55022, FCC Title 47: Class B, GB9254	
Immunity to		
Electrostatic Discharge	IEC61000-4-2	Level 4 Criteria A ¹⁾ Air Discharge: 15kV Contact Discharge: 8kV
Radiated Field	IEC61000-4-3	Level 3 Criteria A ¹⁾ 80MHz-1GHz, 10V/M with 1kHz tone / 80% modulation
Electrical Fast Transient / Burst	IEC61000-4-4	Level 3 Criteria A ¹⁾ 2kV
Surge	IEC61000-4-5	Level 3 Criteria A ¹⁾ Common Mode ²⁾ : 2kV Differential Mode ³⁾ : 2kV
Conducted	IEC61000-4-6	Level 3 Criteria A ¹⁾ 150kHz-80MHz, 10Vrms
Power Frequency Magnetic Fields	IEC61000-4-8	Criteria A ¹⁾ 10A/Meter
Voltage Dips	IEC61000-4-11	100% dip; 1 cycle (20ms); Self Recoverable
Low Energy Pulse Test (Ring Wave)	IEC61000-4-12	Level 3 Criteria A ¹⁾ Common Mode ²⁾ : 2kV Differential Mode ³⁾ : 1kV

1) Criteria A: Normal performance within the specification limits

2) Asymmetrical: Common mode (Line to earth)

3) Symmetrical: Differential mode (Line to line)

PMC Panel Mount Power Supply

12V 100W 1 Phase / PMC-12V100W1AA

Block Diagram

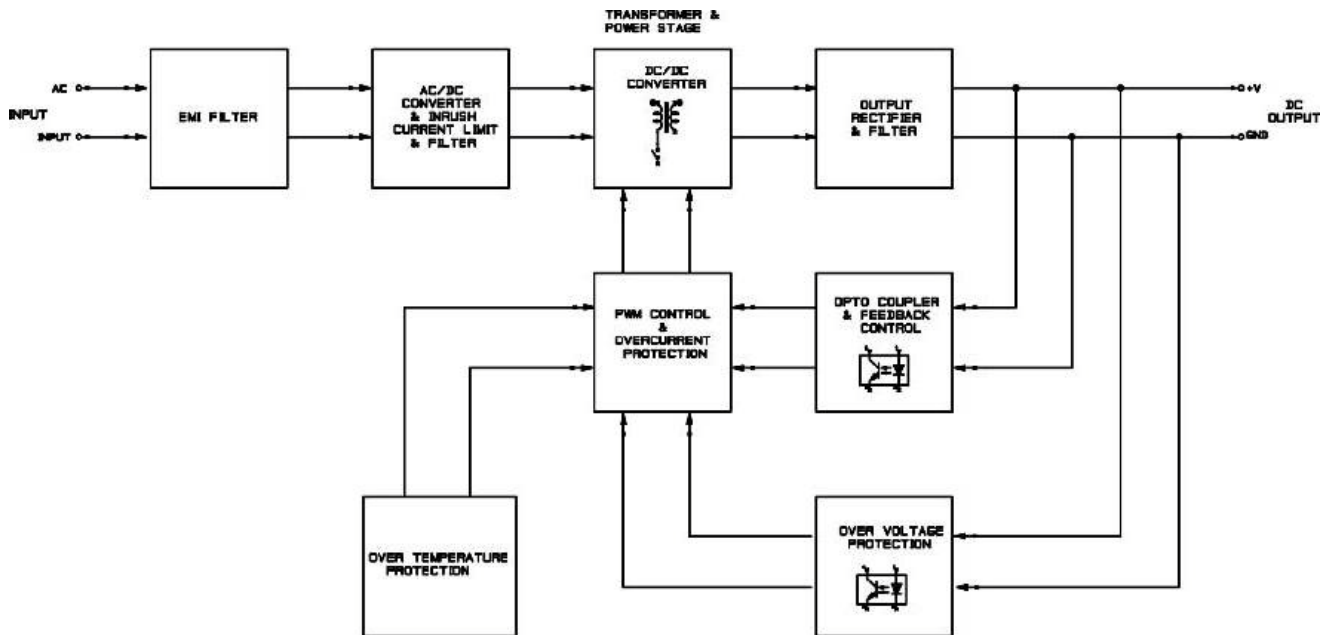

Device Description

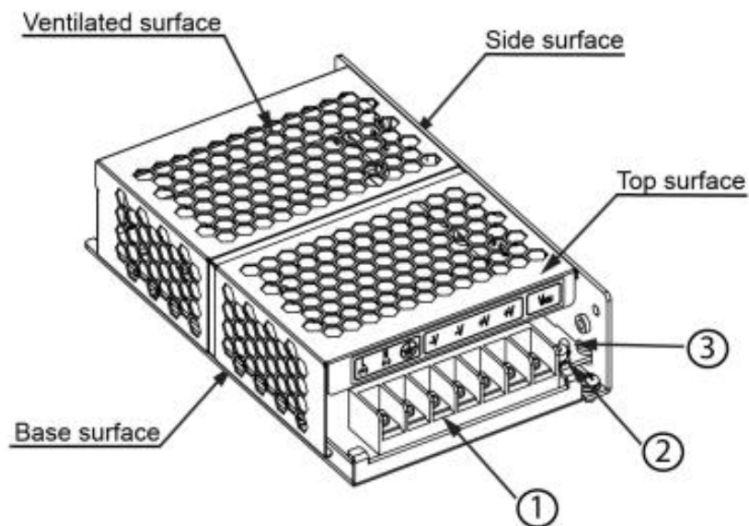

- 1) Input & Output terminal block connector
- 2) DC Voltage adjustment potentiometer
- 3) DC OK control LED (Green)

PMC Panel Mount Power Supply

12V 100W 1 Phase / PMC-12V100W1AA

Dimensions

H x W x D: 158 x 97 x 38 mm

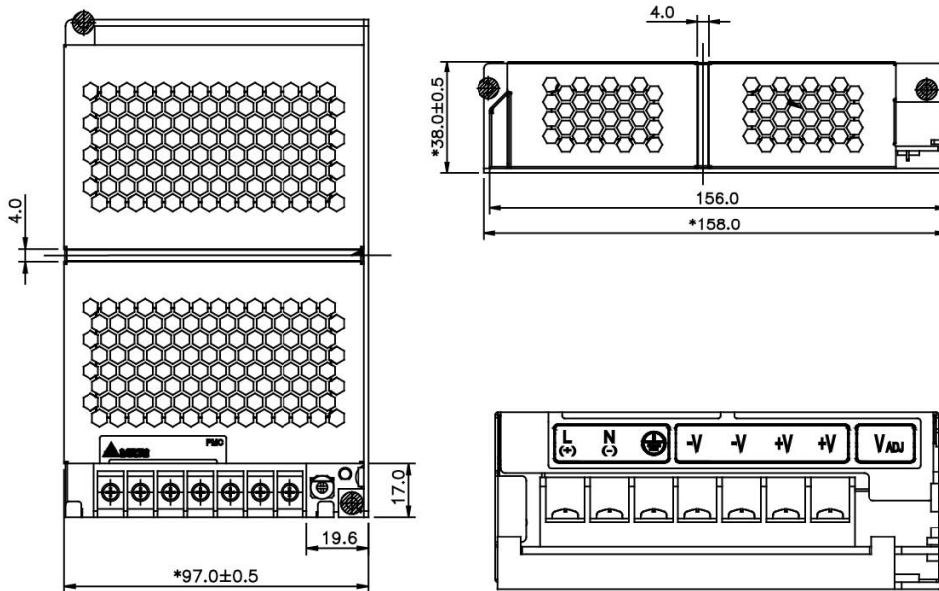

Engineering Data

De-rating VS surrounding air temperature

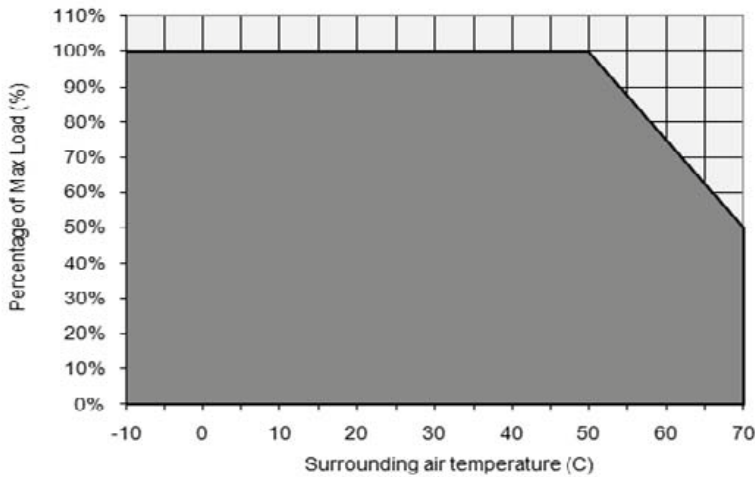

Fig. 1 De-rating for Vertical and Horizontal Mounting Orientation
 > 50°C de-rate power by 2.5% / °C

Note

1. Power supply components may degrade, or be damaged, when the power supply is continuously used outside the shaded region, refer to the graph shown in Fig. 1.
2. If the output capacity is not reduced when the surrounding air temperature > 50°C, the device may run into Over Temperature Protection. When activated, the output voltage will go into bouncing mode and will recover when the surrounding air temperature is lowered or the load is reduced as far as necessary to keep the device in working condition.
3. If the device has to be mounted in any other orientation, please do not hesitate to contact info@deltapsu.com for more details.
4. In order for the device to function in the manner intended, it is also necessary to keep a safety distance of 20mm with adjacent units while the device is in operation.
5. Depending on the surrounding air temperature and output load delivered by the power supply, the device housing can be very hot!

PMC Panel Mount Power Supply

12V 100W 1 Phase / PMC-12V100W1AA

De-rating VS AC input voltage

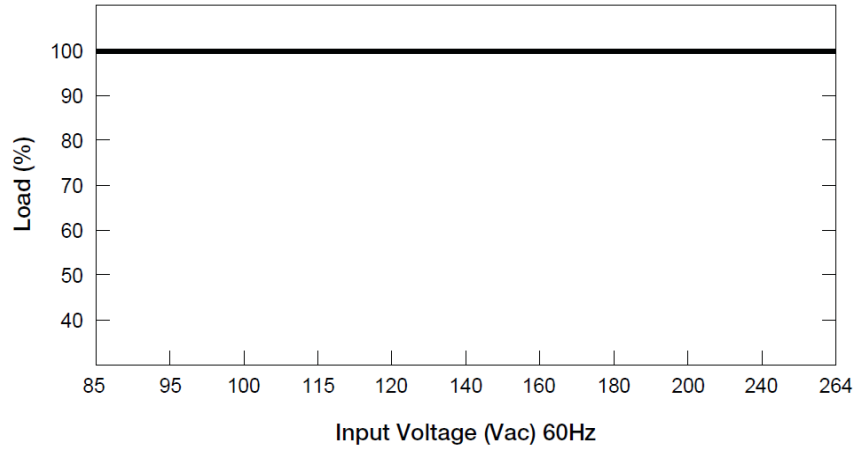

■ No output power de-rating across the entire input voltage range

Assembly & Installation

Mounting

- Ⓐ Mounting holes for power supply assembly onto the mounting surface. Power supply shall be mounted on minimum 2 mounting holes using M3 screw minimum 5 mm length.
- Ⓑ This surface belongs to customer's end system or panel where the power supply is mounted.
- Ⓒ Connector.

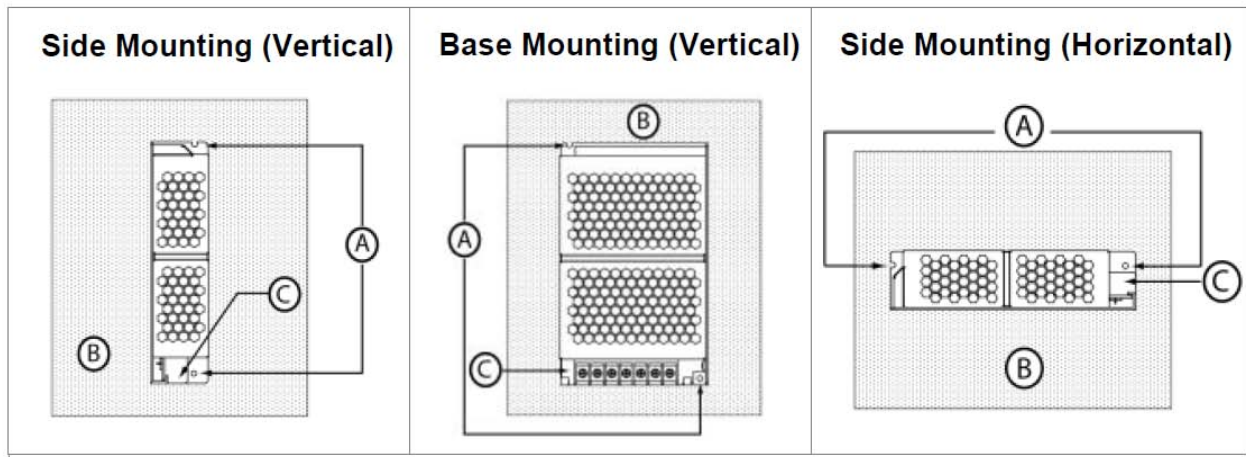
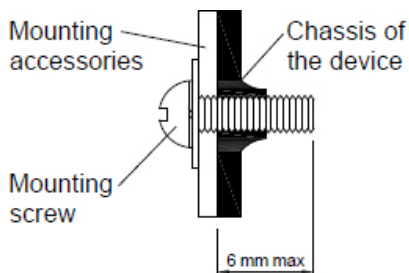

Fig. 2 Mounting Orientation

Installation



- Only use M3 screw ≤ 6 mm through the base mounting holes. This is to keep a safe distance between the screw and internal components.
- Recommended mounting tightening torque : 4~8Kgf.cm

PMC Panel Mount Power Supply

12V 100W 1 Phase / PMC-12V100W1AA

Safety Instructions

- To ensure sufficient convection cooling, always maintain a safety distance of >20mm from all ventilated surfaces while the device is in operation.
- The device is not recommended to be placed on low thermal conductive surface, for example, plastics.
- Note that the enclosure of the device can become very hot depending on the ambient temperature and load of the power supply. Do not touch the device while it is in operation or immediately after power is turned OFF. Risk of burning!
- Do not touch the terminals while power is being supplied. Risk of electric shock.
- Prevent any foreign metal, particles or conductors to enter the device through the openings during installation. It can cause: -
- Electric shock; Safety Hazard; Fire; Product failure
- Warning: When connecting the device, secure Earth connection before connecting L and N. When disconnecting the device, remove L and N connections before removing the Earth connection.

Functions

■ Graph illustrating the Start-up Time, Rise Time, and Hold-up Time

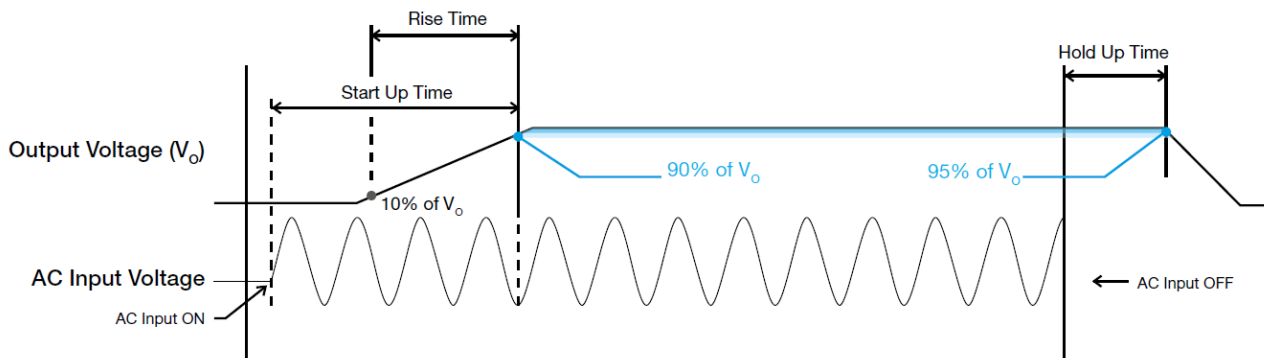

Start-up Time

The time required for the output voltage to reach 90% of its set value, after the input voltage is applied.

Rise Time

The time required for the output voltage to change from 10% to 90% of its set value.

Hold-up Time

Hold up time is the time when the AC input collapses and output voltage retains regulation for a certain period of time. The time required for the output to reach 95% of its set value, after the input voltage is removed.

PMC Panel Mount Power Supply

12V 100W 1 Phase / PMC-12V100W1AA

Inrush Current

Inrush Current is the first surge current seen on the input side when AC input is applied to the power supply. It is the first pulse captured; see a typical picture for the inrush current as seen in the power supply.

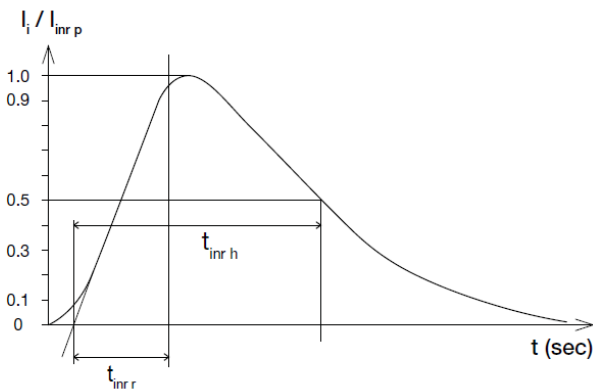

Dynamic Response

The power supply output voltage will remain within $\pm 5\%$ of its steady state value, when subjected to a dynamic load from 0 to 100% of its rated current.

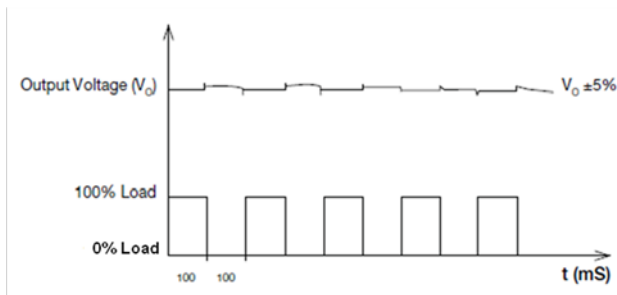

Overvoltage Protection

The power supply's overvoltage circuit will be activated when its internal feedback circuit fails. The output voltage shall not exceed its specifications defined on Page 3 under "Protections".

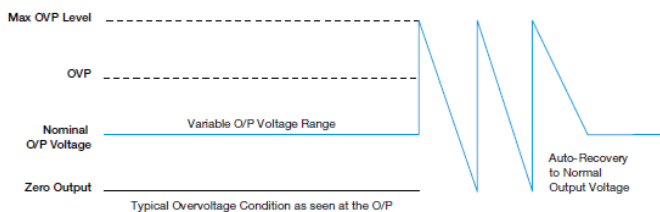

Overload & Overcurrent Protections

The power supply's Overload (OLP) and Over current (OCP) Protections will be activated when output current exceeds 120% of I_o (Max load). In such occurrence, the V_o will start to droop and once the power supply has reached its maximum power limit, the protection is activated and the power supply will go into "Hiccup mode" (Auto-Recovery). The power supply will recover once the fault condition of the OLP and OCP is removed and I_o is back within the specifications.

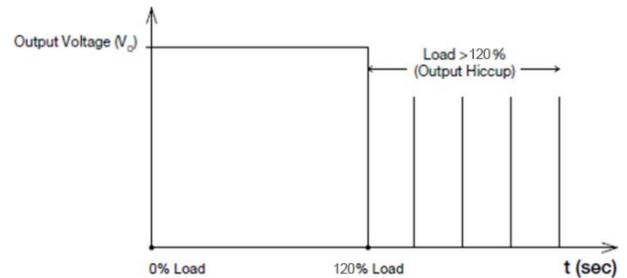

Additionally, if the I_o is $< 120\%$ but $> 100\%$ for a prolonged period of time (depending on the load), the Over Temperature Protection (OTP) will be activated due to high temperature on critical components. The power supply will then go into "Hiccup mode" until power supply cool down.

Over Temperature Protection

As mentioned above, the power supply also has Over Temperature Protection (OTP). This is activated when the overload condition persists for an extended duration and the output current is below the overload trigger point but $> 100\%$ load. In the event of a higher operating condition at 100% load, the power supply will run into OTP when the surrounding air temperature is $> 75^\circ\text{C}$. When activated, the output voltage will go into bouncing mode until the operating surrounding temperature drops to 50°C or output capacity is reduced as recommended in the de-rating graph.

Short Circuit Protection

The power supply's output OLP/OCP function also provides protection against short circuits. When a short circuit is applied, the output current will operate in "Hiccup mode", as shown in the illustration in the OLP/OCP section on this page. The power supply will return to normal operation after the short circuit is removed.

PMC Panel Mount Power Supply

12V 100W 1 Phase / PMC-12V100W1AA

Others

Delta RoHS Compliant



Restriction of the usage of hazardous substances

The European directive 2011/65/EU limits the maximum impurity level of homogeneous materials such as lead, mercury, cadmium, chrome, polybrominated flame retardants PBB and PBDE for the use in electrical and electronic equipment. RoHS is the abbreviation for "Restriction of the use of certain hazardous substances in electrical and electronic equipment".

This product conforms to this standard.

PFC – Norm EN 61000-3-2

Line Current harmonic

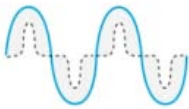

Typically, the input current waveform is not sinusoidal due to the periodical peak charging of the input capacitor. In industrial environment, complying with EN 61000-3-2 is only necessary under special conditions. Complying to this standard can have some technical drawbacks, such as lower efficiency as well as some commercial aspects such as higher purchasing costs. Frequently, the user does not profit from fulfilling this standard, therefore, it is important to know whether it is mandatory to meet this standard for a specific application.

This product conforms to this standard.