

# CliQ II DIN Rail Power Supply

24V 60W 1 Phase / NEC Class 2 / DRP024V060W1N□



## Highlights & Features

- Reliable design, with expected life of 10 years
- Compact, rugged design for ease of handling and installation
- Multiple connections to terminals allowed
- With Conformal Coating on PCBA (DRP024V060W1NZ)
- Class I, Div 2 Hazardous Locations (DRP024V060W1NY)
- IP20 Compliant
- NEC Class 2 Compliant
- Meets worldwide safety requirements
- RoHS Directive 2011/65/EU Compliant
- Worldwide AC input range without power de-rating
- Overvoltage / Overcurrent / Over Temperature Protections

## Safety Standards



CB Certified for worldwide use

**Model Number:** DRP024V060W1N□

**Unit Weight:** 0.33 kg

**Dimensions (L x W x D):** 120.6 x 32 x 119.3 mm

## General Description

The CliQ II 24V 60W NEC Class 2 certified power supply is the latest offering from one of the world's largest power supply manufacturers and solution providers - Delta. The product can be used in general industrial applications, especially for dry indoor condition with the advantage of lower wiring costs for a system due to its compliance with NEC Class 2 requirements. The NEC (National Electrical Code) is a North American standard, which is regarded as a law in most North American states. The NEC describes the installation of electric conductors and equipments within or on buildings. The DRP024V060W1NZ features universal AC input and a high efficiency of more than 87%. The product has an expected life time of 10 years and will have no output power de-rating for the entire range of input voltage from 85Vac to 264Vac. This is useful for systems that require full output power at low input voltage. Typical DIN Rail power supply with similar specifications starts to de-rate at input voltage below 90Vac.

## Model Information

### CliQ DIN Rail Power Supply

Model Number	Input Voltage Range	Output Voltage	Output Current
DRP024V060W1N□	85-264Vac	24Vdc	2.5A

## Model Numbering

DRP	P	024V	060W	1	N	□
DIN Rail	Power Supply	Output Voltage	Output Power	Single Phase	NEC Class 2	Y – Plastic case, with Class I, Div 2 Z – Plastic case, without Class I, Div 2

# CliQ II DIN Rail Power Supply

## 24V 60W 1 Phase / NEC Class 2 / DRP024V060W1N□

### Specifications

#### Input Ratings / Characteristics

Nominal Input Voltage	100-240Vac
Input Voltage Range	85-264Vac
Nominal Input Frequency	50-60Hz
Input Frequency Range	47-63Hz
Input Current	< 1.50A @ 100Vac
Efficiency	> 86.0% @ 115Vac, > 87.0% @ 230Vac
Max Inrush Current	< 40A @ 115Vac, < 80A @ 230Vac
Power Factor	Conform to EN61000-3-2
Leakage Current	< 1mA @ 240Vac

#### Output Ratings / Characteristics

Nominal Output Voltage	24Vdc
Output Voltage Tolerance	± 2% (initial set point tolerance)
Output Voltage Adjustment Range	22-28Vdc
Output Current	2.5A
Output Power	60W
Line Regulation	< 0.5% typ. (@ 85-264Vac input, 100% input)
Load Regulation	< 1% typ. (@ 85-264Vac input, 0-100% input)
Residual Ripple / PARD (20MHz)	< 50mVpp / <240mVpp @ 25°C
Rise Time	< 100ms @ nominal input (100% load, 25°C)
Start-up Time	< 3000ms @ nominal input (100% load, 25°C)
Hold-up Time	> 20ms @ 115Vac, > 125ms @ 230Vac (100% load, 25°C)
Dynamic Response (Overshoot & Undershoot O/P Voltage)	± 5% @ 10-100% load
Start-up with Capacitive Loads	8,000µF Max

#### Mechanical

Case Cover	Plastic
Dimensions (L x W x D)	120.6 x 32 x 119.3 mm
Unit Weight	0.33 kg
Indicator	Green LED (DC OK)
Cooling System	Convection
Terminal	Input M3 x 3 Pins (Rated 300V/30A) Output M3 x 2 Pins (Rated 300V/30A)
Wire	Input AWG 22-10 Output AWG 22-10
Mounting Rail	Standard TS35 DIN Rail in accordance with EN60715

# CliQ II DIN Rail Power Supply

## 24V 60W 1 Phase / NEC Class 2 / DRP024V060W1N□

### Environment

Surrounding Air Temperature	Operating	-25°C to +85°C
	Storage	-25°C to +85°C
Power De-rating		> 50°C de-rate power by 2.5% / °C > 70°C de-rate power by 4% / °C
Operating Humidity		< 95% RH (Non-Condensing)
Operating Altitude		2,500 Meters
Shock Test (Non-Operating)		IEC60068-2-27, 30G (300m/S <sup>2</sup> ) for a duration of 18ms
Vibration (Non-Operating)		IEC60068-2-6, 10Hz to 500Hz @ 30m/S <sup>2</sup> (3G peak); 60 min per axis for all X, Y, Z direction
Bump		IEC60068-2-29; 11ms / 10gn
Pollution Degree		2

### Protections

Overvoltage	<32V ±10%, SELV Output, Hicc-up Mode, Non-Latching (Auto-Recovery)
Overload / Overcurrent	> 120% & 150% of rated load current, Hicc-up Mode, Non-Latching (Auto-Recovery)
Over Temperature	< 80°C Surrounding Air Temperature @ 100% load, Non-Latching (Auto-Recovery)
Short Circuit	Hicc-up Mode, Non-Latching (Auto-Recovery when the fault is removed)
Degree of Protection	IP20
Protection Against Shock	Class I without PE* connection

\*PE: Primary Earth



### Reliability Data

MTBF	> 800,000 hrs. as per Telcordia SR-332
Expected Cap Life Time	10 years (115Vac & 230Vac, 50% load @ 40°C)

# CliQ II DIN Rail Power Supply

## 24V 60W 1 Phase / NEC Class 2 / DRP024V060W1N□

### Safety Standards / Directives

Electronic Equipment in Power Installations	EN50718 / IEC62103
Electrical Safety	SIQ to EN60950-1, UL/cUL recognized to UL60950-1, CSA C22.2 No. 60950-1, CB scheme to IEC60950-1, Limited Power Source (LPS)
Industrial Control Equipment	UL/cUL listed to UL508 and CSA C22.2 No. 107.1-01, CSA to CSA C22.2 No. 107.1-01
Hazardous Location / ATEX (For DRP024V060W1NY)	CSA to CSA C22.2 No. 213-M1987, ANSI / ISA 12.12.01:2007 (Class I, Division 2, Group A, B, C, D, T4) EN60079-0:2009, EN60079-15:2010 (  II 3G Ex nA nC IIc T4 Gc)
 II 3G ATEX 94/9/EC; (For DRP024V060W1BA) IECEX Test Report	Certificate No. ESP 12 ATEX 1 491 X; For IEC60079-0, IEC60079-15
CE	In conformance with EMC Directive 2004/108/EC and Low Voltage Directive 2006/95/EC  For DRP024V060W1NY: In conformance with Equipment for explosive atmospheres (ATEX) directive 94/9/EC
Material and Parts	RoHS Directive 2011/65/EU Compliant
Galvanic Isolation	Input to Output 4.0KVac Input to Ground 1.5KVac Output to Ground 1.5KVac

### EMC

EMC / Emissions	CISPR22, EN55022, EN55011, FCC Title 47: Class B
Component Power Supply for General Use	EN61204-3
Immunity to	
Electrostatic Discharge	EN61000-4-2 Level 4 Criteria A <sup>1)</sup> Air Discharge: 15kV Contact Discharge: 8kV
Radiated Field	EN61000-4-3 Level 3 Criteria A <sup>1)</sup> 80MHz–1GHz, 10V/M with 1kHz tone / 80% modulation
Electrical Fast Transient / Burst	EN61000-4-4 Level 3 Criteria A <sup>1)</sup> 2kV
Surge	IEC6100-4-5 Level 3 Criteria A <sup>1)</sup> Common Mode <sup>2)</sup> : 2kV Differential Mode <sup>3)</sup> : 1kV
Conducted	EN61000-4-6 Level 3 Criteria A <sup>1)</sup> 150kHz-80MHz, 10Vrms
Power Frequency Magnetic Fields	EN61000-4-8 Level 3 Criteria A <sup>1)</sup> 10A/Meter
Voltage Dips	EN61000-4-11 Level 3 Criteria A <sup>1)</sup> 100% dip; 1 cycle (20ms); Self Recoverable
Low Energy Pulse Test (Ring Wave)	IEC61000-4-12 Level 3 Criteria A <sup>1)</sup> Common Mode <sup>2)</sup> : 2kV Differential Mode <sup>3)</sup> : 1kV

1) Criteria A: Normal performance within the specification limits

2) Asymmetrical: Common mode (Line to earth)

3) Symmetrical: Differential mode (Line to line)

# CliQ II DIN Rail Power Supply

24V 60W 1 Phase / NEC Class 2 / DRP024V060W1N□

## Block Diagram

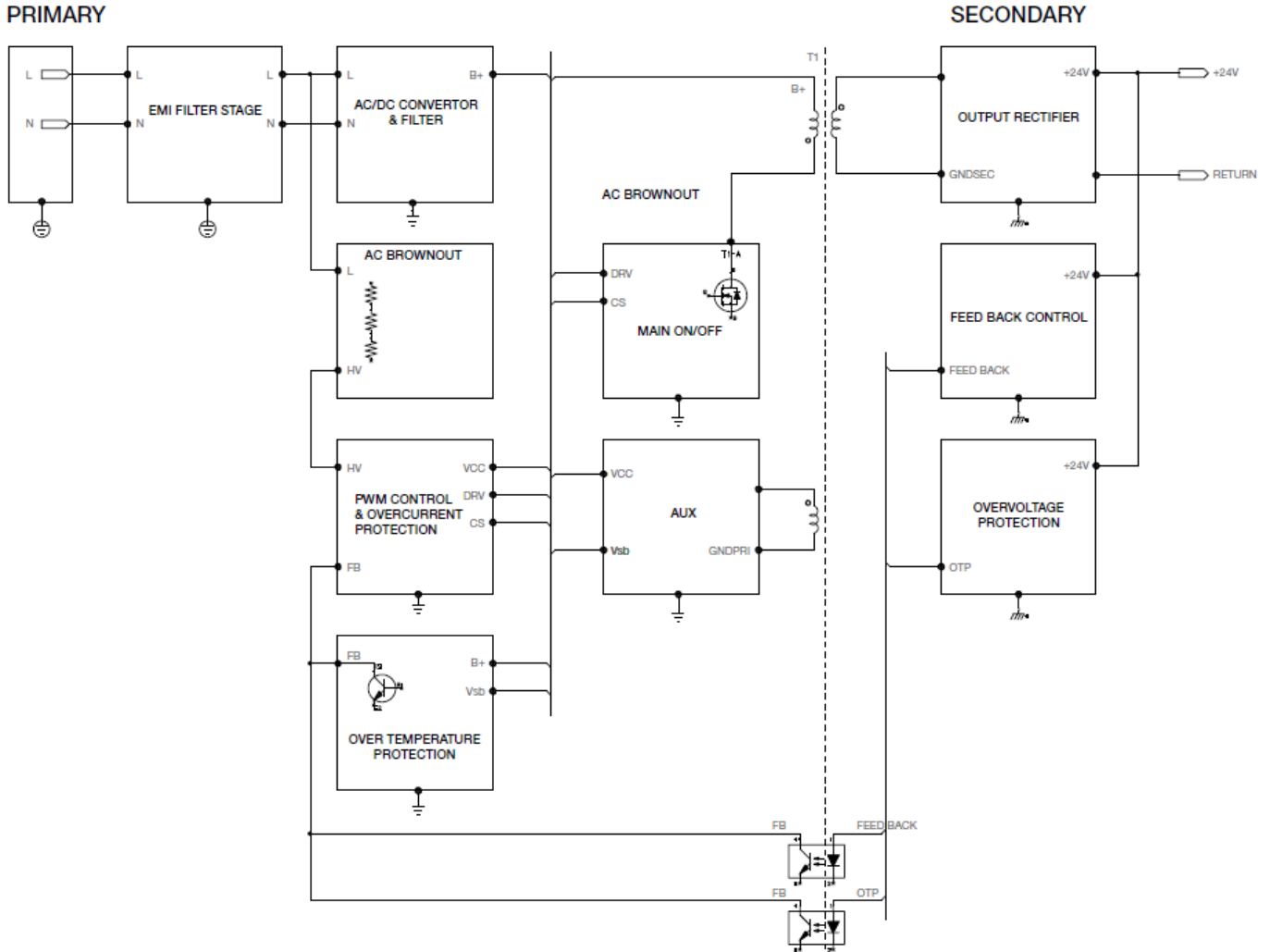

# CliQ II DIN Rail Power Supply

24V 60W 1 Phase / NEC Class 2 / DRP024V060W1N□

## Device Description

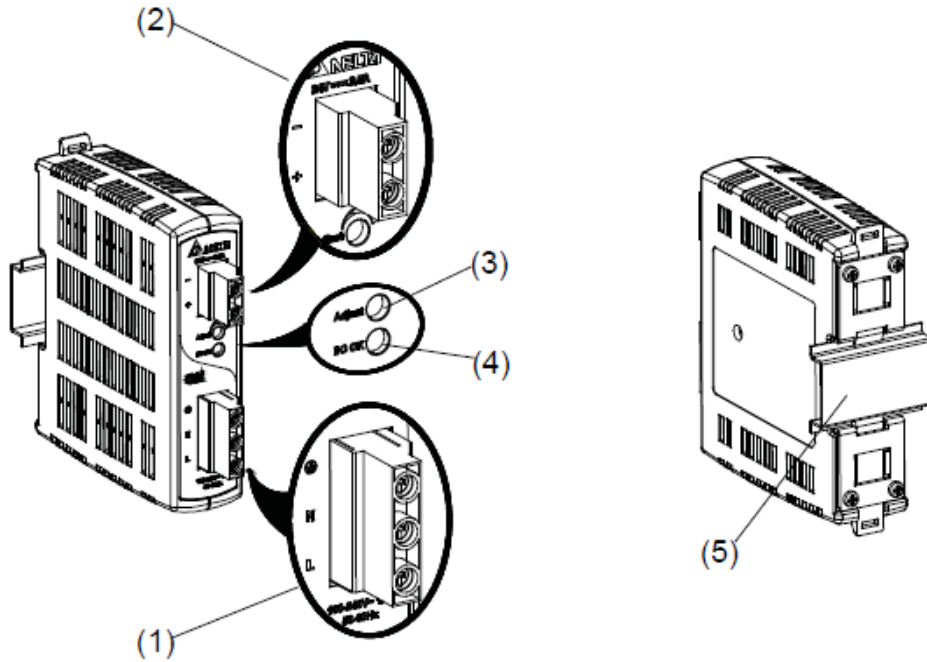

- 1) Input terminal block connector
- 2) Output terminal block connector
- 3) DC voltage adjustment potentiometer
- 4) DC OK control LED (Green)
- 5) Universal mounting rail system

## Dimensions

L x W x D: 120.6 x 32 x 119.3 mm

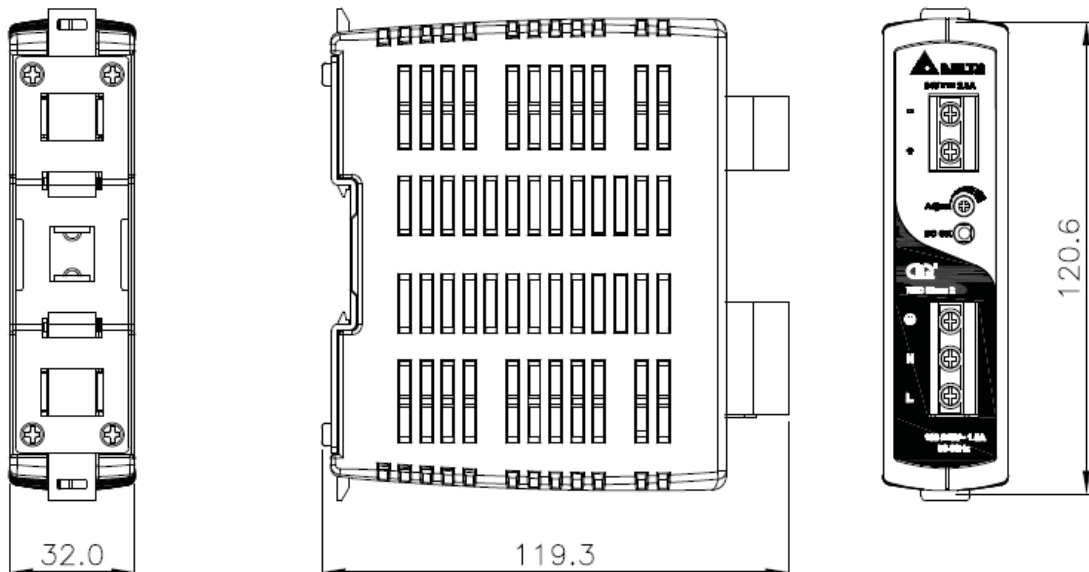

# CliQ II DIN Rail Power Supply

24V 60W 1 Phase / NEC Class 2 / DRP024V060W1N□

## Engineering Data

### De-rating

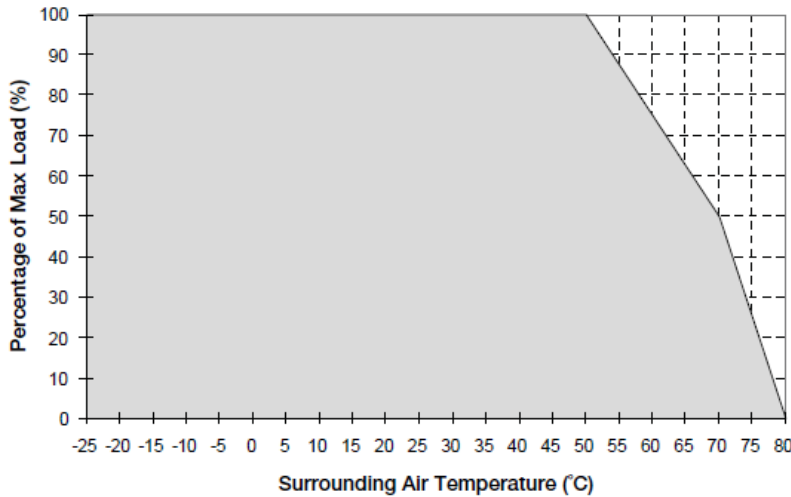
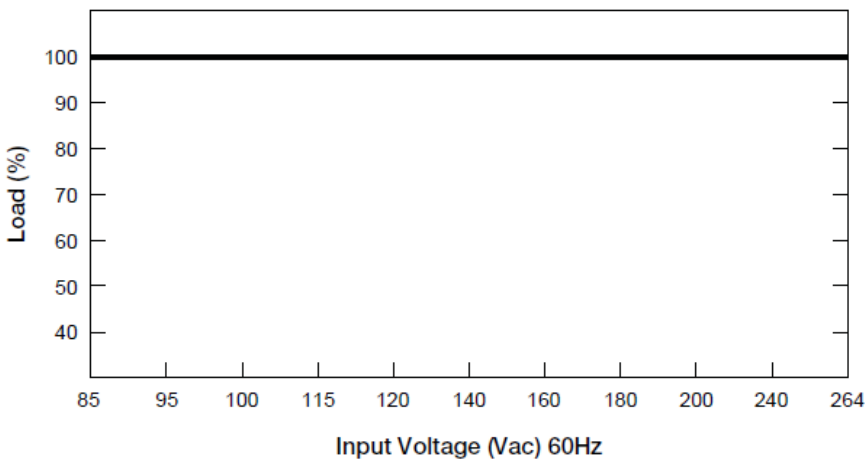

**Fig. 1.1 De-rating for Vertical and Horizontal Mounting Orientation**  
 > 50°C de-rate power by 2.5% / °C  
 > 70°C de-rate power by 4% / °C

### Note

1. Power supply components may degrade, or be damaged, when the power supply is continuously used outside the shaded region, refer to the graph shown in Fig. 1.1.
2. If the output capacity is not reduced when surrounding air temperature >50°C, the device will run into Over Temperature Protection. When activated, the output voltage will go into bouncing mode and will recover when the surrounding air temperature is lowered or the load is reduced as far as necessary to keep the device in working condition.
3. If the device has to be mounted in any other orientation, please do not hesitate to contact [info@deltapsu.com](mailto:info@deltapsu.com) for more details.
4. In order for the device to function in the manner intended, it is also necessary to keep a safety distance of 20mm with adjacent units while the device is in operation.
5. Depending on the surrounding air temperature and output load delivered by the power supply, the device housing can be very hot!

### Output De-rating VS. Input Voltage



■ No output power de-rating across the entire input voltage range

# CliQ II DIN Rail Power Supply

24V 60W 1 Phase / NEC Class 2 / DRP024V060W1N□

## Assembly & Installation

The power supply unit (PSU) can be mounted on 35mm DIN rails in accordance with EN60715. The device should be installed with input terminal blocks at the bottom.

Each device is delivered ready to install.

### Mounting

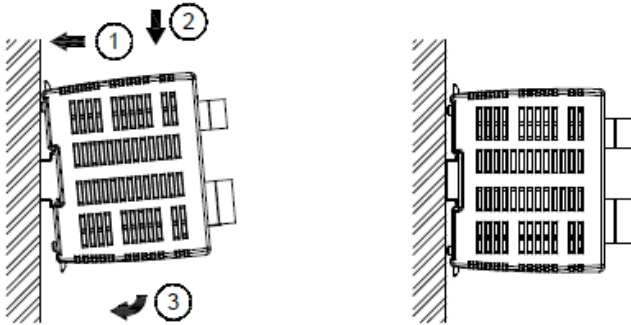

Fig. 2.1 Mounting

Snap on the DIN rail as shown in Fig. 2.1:

1. Tilt the unit upwards and insert it onto the DIN rail.
2. Push downwards until stopped.
3. Press against the bottom front side for locking.
4. Shake the unit slightly to ensure that it is secured.

### Dismounting

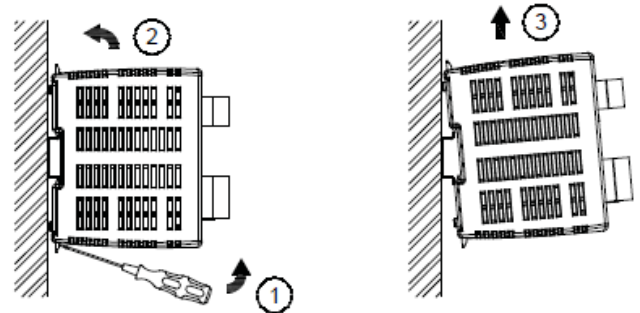
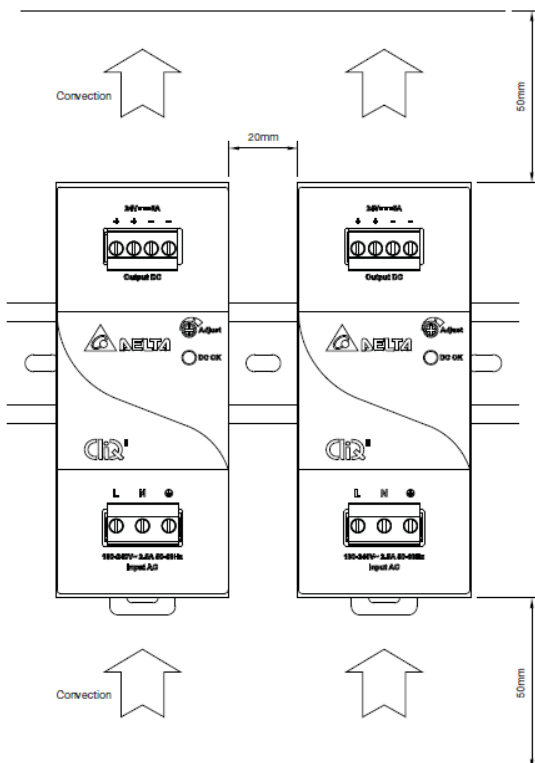

Fig. 2.2 Dismounting

To uninstall, pull or slide down the latch as shown in Fig. 2.2.

Then slide the PSU in the opposite direction, release the latch and pull out the PSU from the rail.

## Safety Instructions



- ALWAYS switch mains of input power OFF before connecting and disconnecting the input voltage to the unit. If mains are not turned OFF, there is risk of explosion / severe damage.
- **To guarantee sufficient convection cooling, keep a distance of 50mm above and below the device as well as a lateral distance of 20mm to other units.**
- Note that the enclosure of the device can become very hot depending on the surrounding air temperature and load of the power supply. Risk of burns!
- Only plug in and unplug connectors when power is turned off!
- DO NOT insert any objects into the unit.
- Hazardous voltages may be present for up to 5 minutes after the input mains voltage is disconnected. Do not touch the unit during this time.
- The power supplies unit must be installed in an IP54 enclosure.
- The power supplies are built in units and must be installed in a cabinet or room (condensation free environment and indoor location) that is relatively free of conductive contaminants.



# CliQ II DIN Rail Power Supply

24V 60W 1 Phase / NEC Class 2 / DRP024V060W1N□

## Functions

■ Graph illustrating the Start-up Time, Rise Time, and Hold-up Time

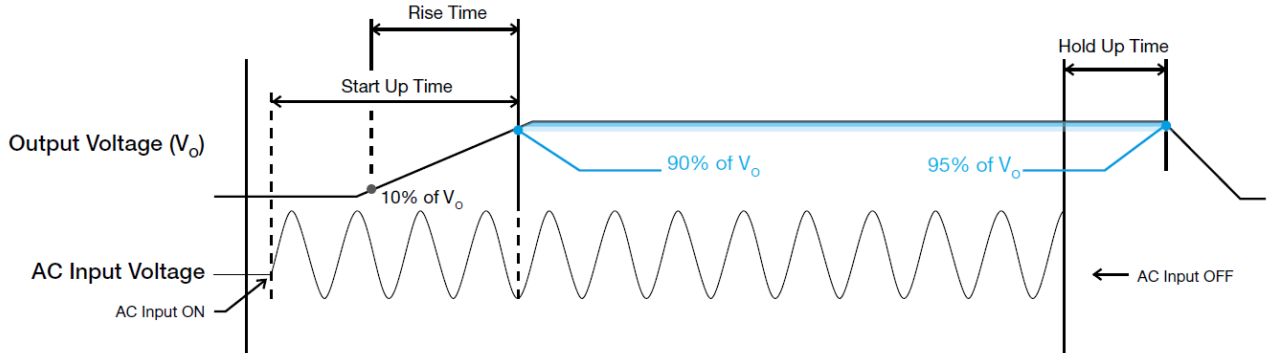

### Start-up Time

The time required for the output voltage to reach 90% of its set value, after the input voltage is applied.

### Rise Time

The time required for the output voltage to change from 10% to 90% of its set value.

### Hold-up Time

Hold up time is the time when the AC input collapses and output voltage retains regulation for a certain period of time. The time required for the output to reach 95% of its set value, after the input voltage is removed.

### Inrush Current

Inrush current is the peak, instantaneous, input current measured and, occurs when the input voltage is first applied. For AC input voltages, the maximum peak value of inrush current will occur during the first half cycle of the applied AC voltage. This peak value decreases exponentially during subsequent cycles of AC voltage.

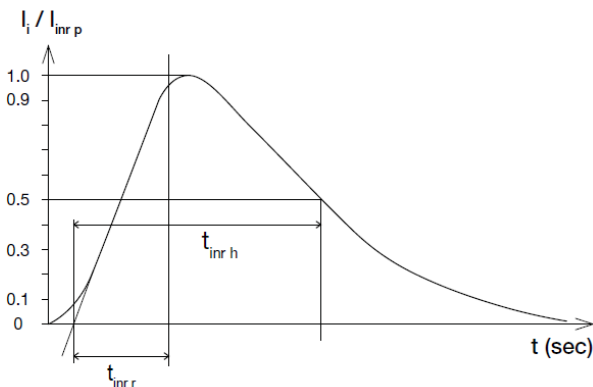

### Step Load Response

The power supply output voltage will remain within  $\pm 5\%$  of its steady state value, when subjected to a dynamic load from 10 to 100% of its rated current.

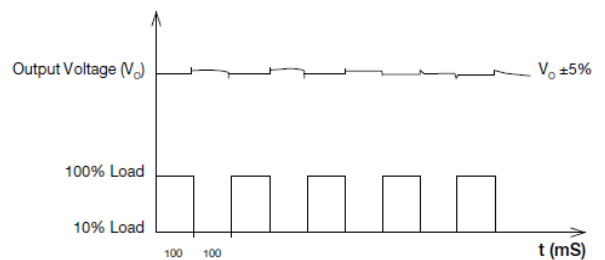

# CliQ II DIN Rail Power Supply

24V 60W 1 Phase / NEC Class 2 / DRP024V060W1N□

## Overload & Overvoltage Protections

The power supply's Overload (OLP) and Overcurrent (OCP) Protections will be activated when output current exceeds 150% of IO (Max load). In such occurrence, the VO will start to droop and once the power supply has reached its maximum power limit, the protection is activated and the power supply will go into "Hiccup mode" (Auto-Recovery). The power supply will recover once the fault condition of the OLP and OCP is removed and IO is back within the specifications.

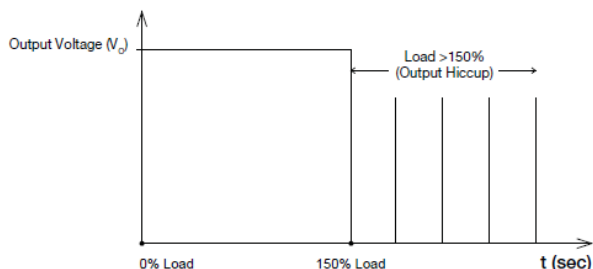

Additionally, if the IO is <150% but >100% for a prolonged period of time (depending on the load), the Over Temperature Protection (OTP) will be activated due to high temperature on critical components. The power supply will then go into "Hiccup mode" until the fault is removed.

## Overvoltage Protection

The power supply's overvoltage circuit will be activated when its internal feedback circuit fails. The output voltage shall not exceed its specifications defined on Page 3 under "Protections".

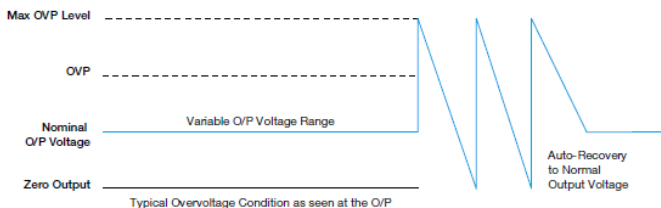

## Over Temperature Protection

As mentioned above, the power supply also has Over Temperature Protection (OTP). This is activated when the overload condition persists for an extended duration and the output current is below the overload trigger point but >100% load. In the event of a higher operating condition at 100% load, the power supply will run into OTP when the surrounding air temperature is >80°C. When activated, the output voltage will go into bouncing mode until the operating surrounding air temperature drops to 50°C or output capacity is reduced as recommended in the derating graph.

## Short Circuit Protection

The power supply's output OLP/OCP function also provides protection against short circuits. When a short circuit is applied, the output current will operate in "Hiccup mode", as shown in the illustration in the OLP/OCP section on this page. The power supply will return to normal operation after the short circuit is removed.

# CliQ II DIN Rail Power Supply

24V 60W 1 Phase / NEC Class 2 / DRP024V060W1N□

## Operating Mode

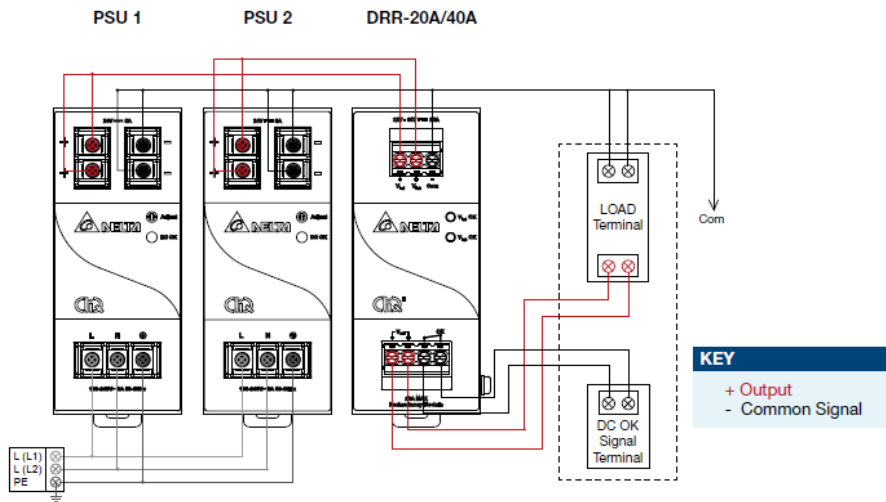

Fig. 3.1 Redundancy / Parallel Operation Connection Diagram

\* $V_{drop}$  will vary from 0.60V to 0.90V (Typical 0.65V) depending on the load current and surrounding air temperature.

### ■ Parallel Operation

These DRR modules can also be used for Parallel function in order to increase the output power by N+1 (e.g. 2.5A + 2.5A = 5A or 2.5A + 2.5A + 2.5A = 7.5A) or current sharing, and thus increasing the power supply and system reliability. Though the DRP024V060W1BA is not designed for current sharing, a good current sharing between two power supplies can be achieved by following simple steps as below (Refer to Fig. 4.1 for the Connection Diagram).

#### Step 1.

Set output load condition for both supplies at 50% and measure the output voltages.

#### Step 2.

Adjust output voltages to the same level or within  $\pm 25\text{mV}$  difference.

#### Step 3.

Connect PSU 1 and PSU 2 with the DRR-20A module and measure at  $V_{in 1}$  &  $V_{in 2}$  to verify the voltage difference. Ensure the voltages are within  $\pm 25\text{mV}$ .

#### Step 4.

Output voltage from DRR module  $V_{out}$  will be =  $V_O$  (output voltage of power supply) -  $V_{drop}^*$  (in DRR module).

\* $V_{drop}$  will vary from 0.60V to 0.90V (Typical 0.65V) depending on the load current and surrounding air temperature.

### ■ Redundancy Operation

In order to ensure proper redundancy operation for the power supply unit (PSU), ensure that the output voltage difference between the two units is kept at 0.450~0.50V for 24V supplies. Follow simple steps given below to verify:

#### Step 1.

Measure output voltage of PSU 1 and PSU 2. If PSU 1 is the master unit, then  $V_o$  of PSU 1 must be higher than PSU 2.

In order to set the output voltage, connect the power supply to 50% load and set the PSU 1 and PSU 2 output voltage.

#### Step 2.

Connect the right DRR module, 20A as per the system requirement to the power supply units PSU 1 and PSU 2 at  $V_{in 1}$  &  $V_{in 2}$  respectively.

#### Step 3.

Connect the system load from  $V_{out}$ . Please note that output voltage  $V_{out}$  from DRR module will be =  $V_O$  (output voltage of power supply) -  $V_{drop}^*$  (in DRR module).

# CliQ II DIN Rail Power Supply

## 24V 60W 1 Phase / NEC Class 2 / DRP024V060W1N□

### Others

#### Delta RoHS Compliant



##### Restriction of the usage of hazardous substances

The European directive 2011/65/EC limits the maximum impurity level of homogeneous materials such as lead, mercury, cadmium, chrome, polybrominated flame retardants PBB and PBDE for the use in electrical and electronic equipment. RoHS is the abbreviation for "Restriction of the use of certain hazardous substances in electrical and electronic equipment".

This product conforms to this standard.

#### Conformal Coating

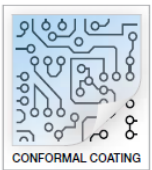

##### The Protective Coating Technology

Delta Electronics Group has designed the perfect dipping technique which penetrates everywhere including under device, and prevents leakage. The conformal coating dipping can be applied to PCBs or circuit board. The coating preserves the performance of precision electronic primarily by preventing ionizable contaminants such as salt from reaching circuit nodes, where the material slumps around sharp edges. This can be a problem especially in highly conversing atmosphere.